



Kids Snapback Cap

Panel Style: 6-Panel Hat

Age Group: Children

Gender: Male

Material: Polyester+cotton+pu

Fabric Feature: COMMON

Style: Character

Pattern: APPLIQUE

Place of Origin: Henan, China

Brand Name: None

Model Number: SML202011

Applicable Season: Four Seasons

Applicable Scene: Sports

Color: Navy blue or custom

Logo: embroidery or custom

Brim: Flat brim

Back closure: Seven holes plastic buckle

Quality: High-end

Sample time: 5-7 Days

Usage: Headwear

Sample fee: Refund

Sweatband: 100% Cotton Sweatband



Supply Ability

500000 Piece/Pieces per Month sublimation trucker hat

Packaging & Delivery

Packaging Details

25pcs/carton,50pcs/carton,100pcs/carton

Port: Qingdao

Lead Time:

Quantity(Pieces)	1 - 100	101 - 1000	1001 - 10000	>10000
Est. Time(days)	15	20	25	To be negotiated

Product Information & Terms Of Business

Item	Baseball Cap	Optional
Product name	sports caps baseball hat	
1.Shape	Constructed	Unconstructed or any other design and shape
2.Panel	6 panel snapback caps	5 panels,6 panels,7 panels etc also other customer's request.
3.Material	cotton	Other material according to buyer's demand such as heavy brushed twill, cotton, Canvas, Polyester, Acrylic etc
4.Color	black/pink /blue and so on	Many colors for your choice.Standard color available (special color available on request to dyed based on pantone color card)
5.Logo	embroidery/leather lable /woven lable	Printing, Patchwork, Flat embroidery, 3D Embroidery, High frequency logo available.Please provide the artwork or pictures or original sample, Alsowe can design on the cap for your request.
6.Back closure	snap back	Brass, Plastic,Buckle, etc.Any kind of back strap closure
7.Size	58cm-60cm	Normally 54cm-62cm for kids and 56cm-60cm for adults
8.MOQ	25pieces	
9.Packing	25PCS/POLYBAG	







SELECT YOUR STYLE



SNAPBACK CAPS



5 PANEL HAT



BASEBALL CAPS



TRUCKER CAPS

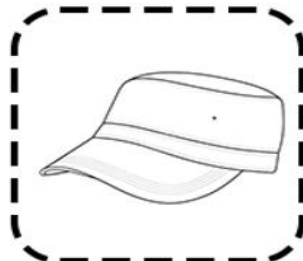

MILITARY CAPS



SUN VISOR



BUCKET HAT



BERETS



KNITTED HAT

CHOOSE CROWN SHAPE

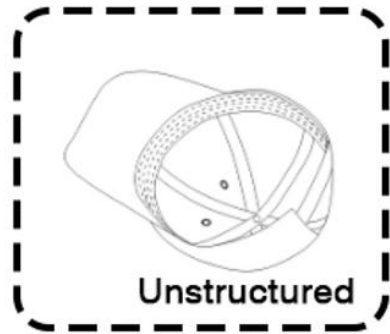
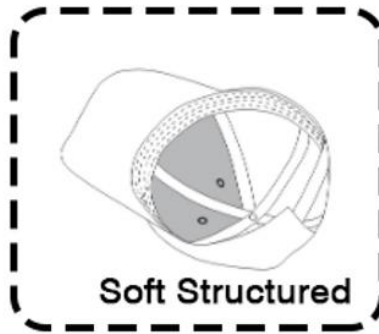
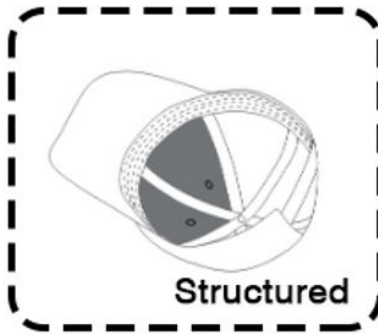
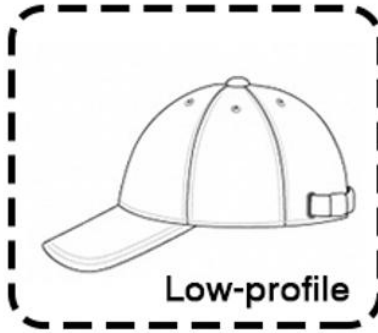

CHOOSE VISOR SHAPE

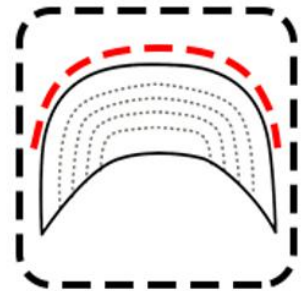
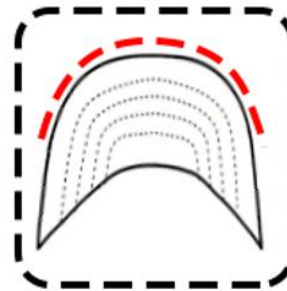
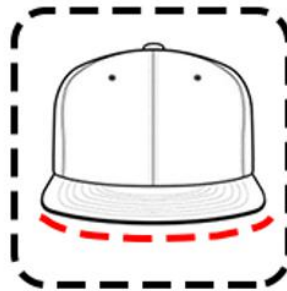



CHOOSE YOUR FABRIC



COTTON TWILL



CANVAS



MESH



ACRYLIC



POLYESTER



MICROFIBRE

APPLY YOUR COLOR



FRONT

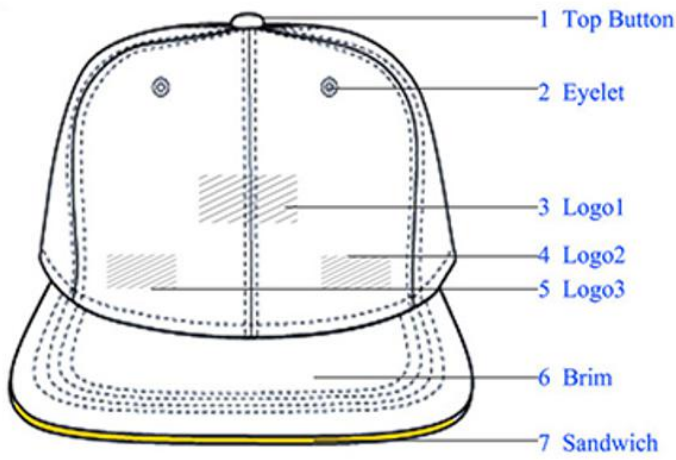

Right

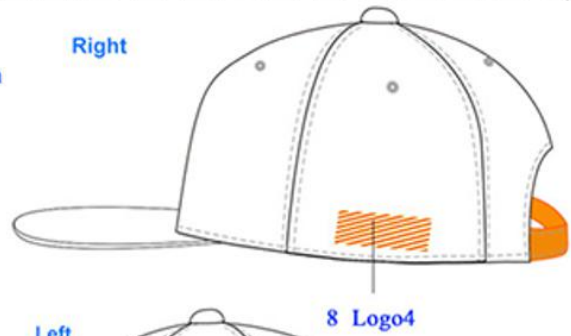

Left

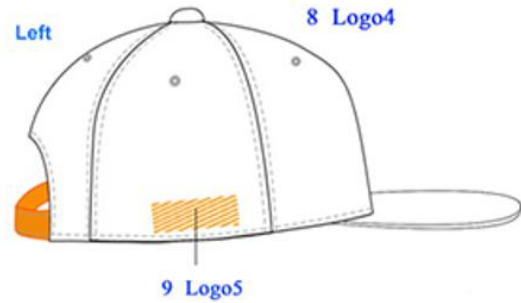

Back

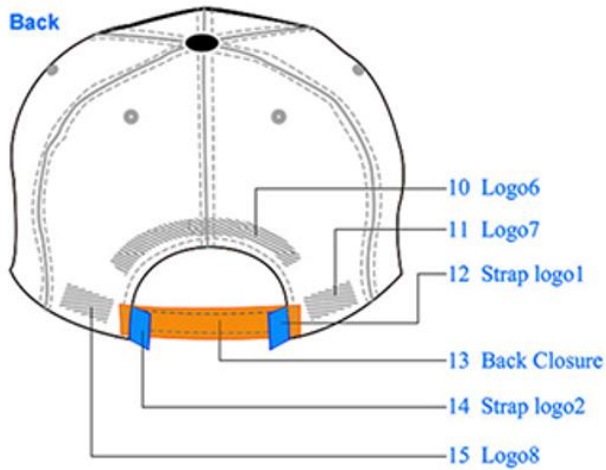

Bottom

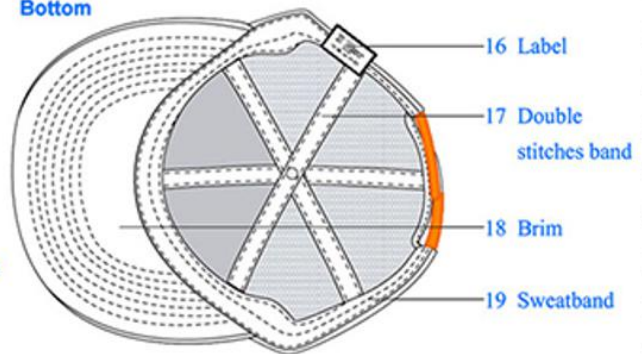

By default, the hat is composed of 1, 2, 3, 6, 13, 17, and 19. If you have other requirements, please tell us the number code and corresponding requirements.

SELECT YOUR OWN LOGO



3D Rubber Logo



Fabric Debossed Logo



Flocking Logo



Heat Pressed Logo



Leather Badge



Rubber Badge



Silicon Logo



Suede Leather Badge



TPU Logo



Woven Badge



Woven Badge



Woven Label

SELECT BACK CLOSURE



Plastic Buckle



Metal Buckle



Magic Sticker



Plastic and Magic Sticker



Metal Buckle



Metal Buckle



Nylon Webbing and
Half round Metal Closure



Sunday Metal Buckle



Leather and Metal Buckle



SELECT YOUR PEAKS



DESIGN YOUR BRAND SEAM TAPES

